

Архангельск (8182)63-90-72
Астана +7(7172)727-132
Белгород (4722)40-23-64
Брянск (4832)59-03-52
Владивосток (423)249-28-31
Волгоград (844)278-03-48
Вологда (8172)26-41-59
Воронеж (473)204-51-73
Екатеринбург (343)384-55-89
Иваново (4932)77-34-06
Ижевск (3412)26-03-58
Казань (843)206-01-48

Калининград (4012)72-03-81
Калуга (4842)92-23-67
Кемерово (3842)65-04-62
Киров (8332)68-02-04
Краснодар (861)203-40-90
Красноярск (391)204-63-61
Курск (4712)77-13-04
Липецк (4742)52-20-81
Магнитогорск (3519)55-03-13
Москва (495)268-04-70
Мурманск (8152)59-64-93
Набережные Челны (8552)20-53-41

Нижний Новгород (831)429-08-12
Новокузнецк (3843)20-46-81
Новосибирск (383)227-86-73
Орел (4862)44-53-42
Оренбург (3532)37-68-04
Пенза (8412)22-31-16
Пермь (342)205-81-47
Ростов-на-Дону (863)308-18-15
Рязань (4912)46-61-64
Самара (846)206-03-16
Санкт-Петербург (812)309-46-40
Саратов (845)249-38-78

Смоленск (4812)29-41-54
Сочи (862)225-72-31
Ставрополь (8652)20-65-13
Тверь (4822)63-31-35
Томск (3822)98-41-53
Тула (4872)74-02-29
Тюмень (3452)66-21-18
Ульяновск (8422)24-23-59
Уфа (347)229-48-12
Челябинск (351)202-03-61
Череповец (8202)49-02-64
Ярославль (4852)69-52-93

www.barthel.nt-rt.ru || bet@nt-rt.ru

АКСЕССУАРЫ

Каталог Barthel Armaturen

Handrad, gekröpft

cranked handwheel

DIN 390-B

Wellenkranz

gerader Vierkant

Gehäuse: Grauguss

Innenteile: -

Sitzdichtung: -

fully profiled rim

parallel square

body: cast iron

inner parts: -

seat sealing: -

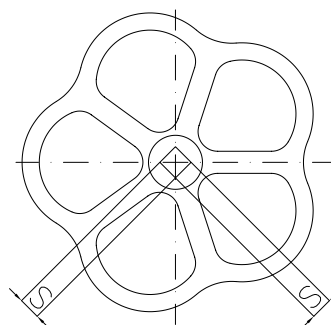
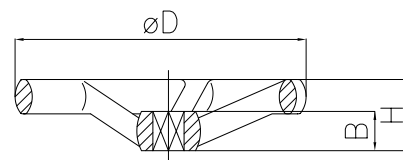

| øD | S | B | H | kg | | | | | | | | | | | |
|-----|----|----|----|------|--|--|--|--|--|--|--|--|--|--|--|
| 60 | 7 | 12 | 20 | 0,08 | | | | | | | | | | | |
| 80 | 8 | 14 | 22 | - | | | | | | | | | | | |
| 80 | 9 | 14 | 22 | 0,13 | | | | | | | | | | | |
| 90 | 10 | 14 | 22 | 0,19 | | | | | | | | | | | |
| 100 | 9 | 14 | 25 | - | | | | | | | | | | | |
| 100 | 11 | 14 | 25 | 0,24 | | | | | | | | | | | |
| 120 | 11 | 15 | 32 | 0,34 | | | | | | | | | | | |
| 120 | 12 | 15 | 32 | 0,34 | | | | | | | | | | | |
| 140 | 12 | 17 | 34 | - | | | | | | | | | | | |
| 160 | 14 | 19 | 34 | - | | | | | | | | | | | |

Aus Rotguss auf Anfrage.

gunmetal on request.

Handrad, gekröpft

Art. 12-060

cranked handwheel

DIN 3319

voller Kranz
 konischer Vierkant
Gehäuse: Grauguss
Innenteile: -
Sitzdichtung: -

fully rim
conical square
body: cast iron
inner parts: -
seat sealing: -

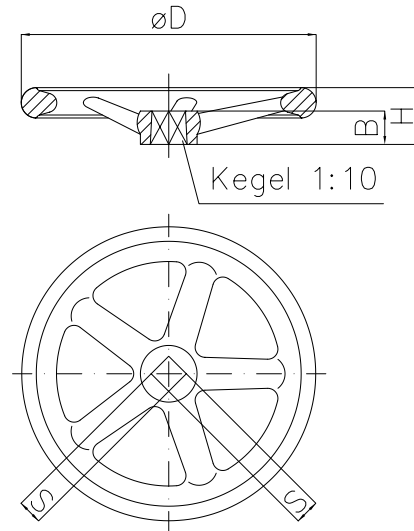

| øD | S | B | H | kg | | | | | | | | | | |
|-----|----|----|----|-------|--|--|--|--|--|--|--|--|--|--|
| 100 | 9 | 17 | 33 | 0,25 | | | | | | | | | | |
| 120 | 11 | 18 | 36 | 0,70 | | | | | | | | | | |
| 160 | 12 | 20 | 40 | 1,20 | | | | | | | | | | |
| 200 | 14 | 22 | 43 | 2,10 | | | | | | | | | | |
| 250 | 17 | 26 | 48 | 4,00 | | | | | | | | | | |
| 315 | 19 | 30 | 53 | 6,00 | | | | | | | | | | |
| 400 | 24 | 34 | 59 | 10,26 | | | | | | | | | | |

Rotguss auf Anfrage.

gunmetal on request.

Handrad, gerade

Art. 12-061

handwheel straight type

DIN 3320

- voller Kranz
- konischer Vierkant
- Gehäuse:** Grauguss
- Innenteile:** -
- Sitzdichtung:** -

- fully rim*
- conical square*
- body:** cast iron
- inner parts:** -
- seat sealing:** -

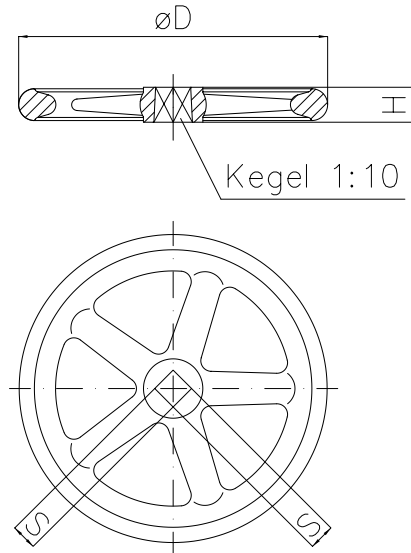

| øD | S | H | kg | | | | | | | | | | | |
|-----|----|----|-------|--|--|--|--|--|--|--|--|--|--|--|
| 100 | 9 | 17 | 0,25 | | | | | | | | | | | |
| 120 | 11 | 18 | 0,70 | | | | | | | | | | | |
| 160 | 12 | 20 | 1,20 | | | | | | | | | | | |
| 200 | 14 | 22 | 2,10 | | | | | | | | | | | |
| 250 | 17 | 26 | 4,00 | | | | | | | | | | | |
| 315 | 19 | 30 | 6,00 | | | | | | | | | | | |
| 400 | 24 | 34 | 10,50 | | | | | | | | | | | |
| 500 | 27 | 38 | 14,50 | | | | | | | | | | | |
| 600 | 32 | 46 | 23,00 | | | | | | | | | | | |

Aus Rotguss auf Anfrage.

gunmetal on request.

Handrad

Art. 12-062

handwheel

verstärkte Nabe

gerader Vierkant

Gehäuse: Stahlblech

Innenteile: -

Sitzdichtung: -

reinforced centre

parallel square

body: steel sheet

inner parts: -

seat sealing: -

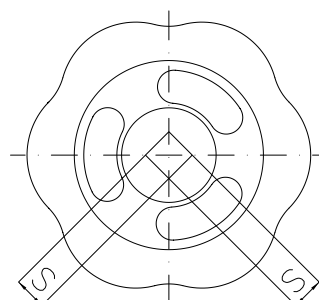
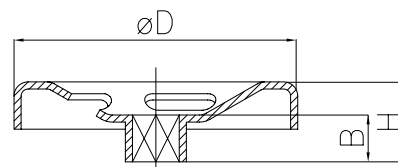

| $\varnothing D$ | S | B | H | kg | | | | | | | | | | | |
|-----------------|----|----|----|------|--|--|--|--|--|--|--|--|--|--|--|
| 50 | 7 | 9 | 15 | 0,02 | | | | | | | | | | | |
| 60 | 7 | 10 | 17 | 0,03 | | | | | | | | | | | |
| 70 | 7 | 10 | 19 | 0,04 | | | | | | | | | | | |
| 80 | 8 | 11 | 20 | 0,06 | | | | | | | | | | | |
| 90 | 9 | - | - | - | | | | | | | | | | | |
| 100 | 10 | 13 | 24 | 0,10 | | | | | | | | | | | |
| 120 | 12 | 16 | 32 | 0,17 | | | | | | | | | | | |
| 160 | 14 | 20 | 37 | 0,31 | | | | | | | | | | | |

Aus Edelstahl auf Anfrage.

stainless steel on request.

Hahnschlüssel

Art. 12-065

cock wrench

DIN 3521

Gehäuse: Temperguss

Innenteile: -

Sitzdichtung: -

body: malleable cast iron

inner parts: -

seat sealing: -

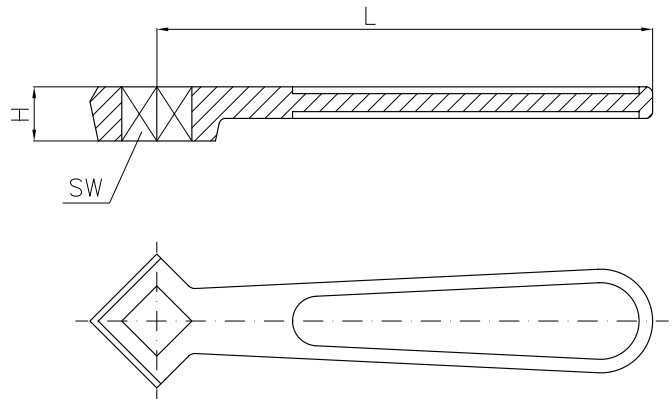

















| SW | L | H | kg | | | | | | | | | | | | |
|----|-----|----|------|--|--|--|--|--|--|--|--|--|--|--|--|
| 7 | 80 | 9 | - | | | | | | | | | | | | |
| 8 | 90 | 10 | 0,03 | | | | | | | | | | | | |
| 9 | 100 | 11 | 0,04 | | | | | | | | | | | | |
| 10 | 105 | 12 | 0,05 | | | | | | | | | | | | |
| 11 | 110 | 12 | 0,06 | | | | | | | | | | | | |
| 12 | 120 | 13 | 0,07 | | | | | | | | | | | | |
| 14 | 130 | 15 | 0,09 | | | | | | | | | | | | |
| 17 | 140 | 18 | 0,13 | | | | | | | | | | | | |
| 19 | 150 | 20 | 0,15 | | | | | | | | | | | | |
| 22 | 175 | 22 | 0,22 | | | | | | | | | | | | |
| 24 | 200 | 24 | 0,30 | | | | | | | | | | | | |
| 27 | 225 | 26 | 0,40 | | | | | | | | | | | | |
| 32 | 250 | 30 | 0,56 | | | | | | | | | | | | |
| 36 | 280 | 34 | 0,80 | | | | | | | | | | | | |
| 41 | 320 | 38 | 1,02 | | | | | | | | | | | | |

Rotguss auf Anfrage.









gunmetal on request.

Druckluftzubehör accessories for compressed air

| | | | |
|---|--|---|---|
|  <p>Sechskant-Überwurfmutter zylindrisches Rechtsgewinde DIN 8542 EN 560 (für brennbare Gase auch mit Linksgewinde)/ <i>hexagon union nut cylindrical righthand thread (for flammable gases left-hand thread)</i> 12-006 ohne Bund/w/o collar 12-006.2 Hochdruckausführung / <i>high pressure type</i></p> |  <p>Schlauchtülle <i>hose nozzle</i> DIN 8542 EN 560 12-007</p> |  <p>Druckluft-Schlauchkupplung DIN 3483 Nockenweite 42 mm Temperguss verzinkt <i>compr. air hose coupling clamp distance 42 mm malleable cast iron</i> 12-010 Gummidichtung/<i>rubber sealing</i> 12-010.1 mit Sicherungsbund/<i>safety collar</i> 12-010.2 drehbar/<i>turnable</i> 12-011 Metalldichtung/<i>metal sealing</i></p> | |
|  <p>Druckluft-Innengewindekupplung DIN 3482 Nockenweite 42 mm Temperguss verzinkt <i>compr. air coupling female thread clamp distance 42 mm malleable cast iron</i> 12-012 Gummidichtung/<i>rubber sealing</i> 12-013 Metalldichtung/<i>metal sealing</i></p> |  <p>Druckluft-Außengewindekupplung DIN 3481 Nockenweite 42 mm Temperguss verzinkt <i>compr. air coupling male thread clamp distance 42 mm malleable cast iron</i> 12-014 Gummidichtung/<i>rubber sealing</i> 12-015 Metalldichtung / <i>metal sealing</i></p> |  <p>Druckluft-Verschlusskupplung Nockenweite 42 mm Temperguss verzinkt <i>cap for compr. air coupling clamp distance 42 mm malleable cast iron</i> 12-016 Gummidichtung/ <i>rubber sealing</i></p> | |
| <p>Kamlok-Kupplungen aus Messing brass Kamlok couplings 12-009</p> | | | <p>Vaterteile/<i>male couplings</i></p>  |
| <p>Mutterteile/<i>female couplings</i></p>  | <p>Schlauchtülle <i>hose nipple</i></p>  <p>Außengewinde <i>male thread</i></p>  <p>Schlauchtülle <i>hose nipple</i></p>  <p>Außengewinde <i>male thread</i></p>  <p>Innengewinde <i>female thread</i></p>  <p>Verschlusskappe <i>cap</i></p>  <p>Innengewinde <i>female thread</i></p>  <p>Verschlussstopfen <i>plug</i></p>  | | |

Material Stahl, Edelstahl, Messing, PA, PP u.w. sowie andere Ausführungen auf Anfrage.
material steel, stainless steel, brass, PA, PP a.o. as other types on request as well.

Druckluftzubehör accessories for compressed air

| | | |
|--|---|--|
|  <p>Wasser-Schlauchkupplung, drehbar Nockenweite 40 mm Messing, <i>hose coupling, turnable</i> clamp distance 40 mm brass 12-017 Gummidichtung/ <i>rubber sealing</i></p> |  <p>Wasser-Innengewindekupplung Nockenweite 40 mm Messing <i>water coupl. female thread</i> clamp distance 40 mm brass 12-018 Gummidichtung/<i>rubber sealing</i> 12-019 Außengewinde/<i>male thread</i></p> |  <p>Wasser-Blindkupplung Nockenweite 40 mm Messing <i>blind coupling</i> clamp distance 40 mm brass 12-019.1 Gummidichtung/ <i>rubber sealing</i></p> |
|  <p>Steckkupplung ST-NV beidseitig Selbstschlussventile Stahl verzinkt/ <i>plug connector</i> <i>both ends self-closing valves</i> steel galv. 12-020 Kupplungs-Muffe mit Innengewinde/ <i>coupling-socket female thread</i> 12-020.1 Kupplungs-Stecker mit Innengewinde/ <i>coupling-plug connector female thread</i> 12-021/12-021.1 nach ISO 7241-B (Typ ST-HNV) acc. to ISO 7241-B (type ST-HNV)</p> |  <p>Steckkupplung ST1-ST6 bds. Selbstschlussventile Stahl verzinkt <i>plug connector</i> <i>both ends self-closing valves</i> steel galv. 12-022 Kupplungs-Muffe mit Schneidringverschraubung <i>coupling-socket cutting ring union</i> 12-024 Kupplungs-Stecker mit Schneidringverschraubung/ <i>coupling-plug connector</i> cutting ring union</p> |  <p>Steckkupplung Flat-Face beidseitig leckölfreie Selbstschlussventile Stahl verzinkt <i>plug connector</i> <i>both ends leak oil-free</i> self-closing valves steel galv. 12-026 Kupplungs-Muffe mit Innengewinde/ <i>coupling-socket female thread</i> 12-027 Kupplungs-Stecker mit Innengewinde/ <i>coupling-plug connector</i> female thread</p> |
|  <p>Schraubkupplung SK1-SK8, druckstoßfest, beidseitig Selbstschlussventile, Stahl verzinkt <i>screw connector</i> <i>pressure surge protected</i> <i>both ends self-closing valves</i> steel galv. 12-029.1 Kupplungs-Muffe Innengewinde oder Schneidringverschraubung/ <i>coupling-socket female thread</i> or cutting ring union 12-030.1 Kupplungs-Stecker Innengewinde oder Schneidringverschraubung/ <i>coupling-plug connector</i> female thread or cutting ring union</p> |  <p>Niederdruck-Steckkupplung, Stahl verzinkt <i>low pressure plug coupling, steel galvanized</i> 12-030 Kupplungs-Muffe mit Schlauchtülle, Innen- oder Außengewinde <i>coupling socket hose nipple, female- or male thread</i> 12-031 Kupplungs-Stecker (Verschlussnippel) mit Schlauchtülle, Innen- oder Außengewinde <i>coupling plug hose nipple, female- or male thread</i> 12-032 Kupplungs-Stecker/Stecknippel mit Schlauchtülle, Innen- oder Außengewinde <i>coupling plug hose nipple, female- or male thread</i></p> | |

Material Stahl, Edelstahl, Messing, PA, PP u.w. sowie andere Ausführungen auf Anfrage.
material steel, stainless steel, brass, PA, PP a.o. as other types on request as well.

Druckluftzubehör accessories for compressed air

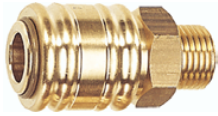

Schnellverschlusskupplung
DN 7,2 mit Außengewinde
Messing blank/
*quick-closing-coupling ND 7,2
male thread
brass bright*
12-025

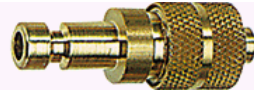

Schnellverschlusskupplung
DN 7,2 mit Schlauchtülle
Messing blank /
*quick-closing-coupling ND 7,2
hose nozzle
brass bright*
12-025.1



Schnellverschlusskupplung
DN 7,2 mit Außengewinde
Messing vernickelt /
*quick-closing-coupling ND 7,2
male thread
brass nickel-plated*
12-025.2

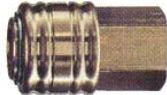

Schnellverschlusskupplung
DN 7,2 mit Schlauchtülle
Messing vernickelt /
*quick-closing-coupling ND 7,2
hose nozzle
brass nickel-plated*
12-025.3



Einstecktülle DN 7,2
mit Außengewinde
Messing blank
*nipple ND 7,2
male thread
brass bright*
12-026



Einstecktülle DN 7,2
Messing vernickelt
*nipple ND 7,2
brass nickel-plated*
12-026.1



Einstecknippel DN 7,2
für Schläuche
Messing blank
*nipple for hoses ND 7,2
brass bright*
12-026



Einstecknippel
DN 7,2 mit Innengewinde
Messing blank
*nipple ND 7,2
female thread
brass bright*
12-026.1



Einstecknippel
DN 7,2 mit Außengewinde
Messing vernickelt
*nipple DN 7,2
male thread
brass nickel-plated*
12-026.2

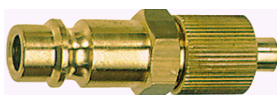

Einstecknippel
DN 7,2 mit Innengewinde
Messing vernickelt/
*nipple ND 7,2
female thread
brass nickel-plated*
12-026.3



Garagenkupplung DN 12
mit Rückschlagventil und
Gummidichtung/
*garage quick-lock coupling ND 12
non-return valve
rubber sealing*
12-028



2-fach bzw. 3-fach Verteiler mit
Schnellverschlusskupplungen DN 7,2
und Innengewinde
Pressmessing
(auch mit Außengewinde)/
*2-way resp. 3-way distribution quick-
lock coupling ND 7,2 female thread
pressed brass
(male thread as well)*

Kupplung mit Innen- oder
Außengewinde/*coupling female-
or male thread*
12-029

Stecker mit Innen- oder
Außengewinde/*plug connector
female- or male thread*

**Material Stahl, Edelstahl, Messing, PA, PP u.w. sowie andere Ausführungen auf Anfrage.
material steel, stainless steel, brass, PA, PP a.o. as other types on request as well.**

Druckluftzubehör accessories for compressed air



Schalldämpfer
mit Sechskant und AG
kompl. aus Sinterbronze/
hexagon, male thread
compl. sintered bronze
12-200



Schalldämpfer mit AG
Vyon /
silencer male thread
Vyon
12-202



Schalldämpfer mit
Sechskant und AG
Sinterbronze/Messing/
silencer
hexagon, male thread
sintered bronze/brass
12-201

Schlauchverschraubungen aus Messing vernickelt/*hose fittings brass nickel-plated*



12-500



12-502.1



12-511



12-600



12-602.1



12-611

Schlauchverschraubungen aus Polyamid/*hose fittings polyamide*



12-700



12-702.1



12-701 mit AG/male thread
12-711 mit IG/female thread



Tankwagenkupplungen nach ISO 14420-6 (DIN 28450)
V- und M- Kupplungen, Blindkappen und -stopfen, einteilige oder verschraubte Ausführung
tank truck couplings acc. to ISO 14420-6 (DIN 28450)
male and female couplings, blind caps and plugs, one-piece or screwed type













Material Stahl, Edelstahl, Messing, PA, PP u.w. sowie andere Ausführungen auf Anfrage.
material steel, stainless steel, brass, PA, PP a.o. as other types on request as well.

Druckluftzubehör accessories for compressed air

| | | |
|--|--|--|
|  <p>Schneckengewinde-Schlauchschelle Breite 9 und 12 mm DIN 3017 <i>hose bracket spiral thread width 9 and 12 mm</i> 12-035 Chromstahl/Stahl verz. (W2)/<i>chrome steel/steel galv.</i> 12-035.1 Edelstahl kompl. (W4)/<i>compl. stainl. steel</i> 12-035.2 Stahl verz. kompl. (W1)/ <i>compl. steel galv.</i> 12-035.3 Edelstahl (1.4571) kompl. (W5)/<i>compl. stainl. steel (1.4571</i> 12-035 SORT Sortimentskasten (W2)/<i>assortment box</i></p> |  <p>Gelenkbolzen-Schlauchschelle mit Zylinderschraube Breite 20/25mm, DIN 912 <i>hose bracket joint bolt cylinder head screw width 20/25 mm acc. to DIN 912</i> 12-037 Stahl verzinkt (W1)/<i>steel galv.</i> 12-037E Edelstahl (W4)/<i>stainless steel</i></p> |  <p>Doppeldrahtklemme <i>double wire clamp</i> 12-037.5 Stahl verz./<i>steel galvanized</i> 12-037.5E Edelstahl/<i>stainless steel</i></p> |
|  <p>Schlauchtülle <i>hose nipple</i> 12-038 Außengewinde, Messing <i>male thread brass</i> 12-039 Außengewinde, Edelstahl <i>male thread stainless steel</i> 12-041 Innengewinde, Messing <i>female thread brass</i></p> |  <p>Schlauchtülle <i>hose nipple</i> 12-040 Überwurfmutter, flachdichtend, Edelstahl <i>nut, flat sealing, stainless steel</i></p> |  <p>Verschlusskappe mit Kette und Dichtring, Messing <i>cap with chain and sealing ring brass</i> 12-045</p> |
|  <p>Gummimetalldichtungen (Schraubendichtungen) <i>rubber metal sealings (screw sealings)</i> 12-072.5</p> |  <p>Kupfer-Dichtungsring DIN 7603 Form A <i>copper-sealing ring</i> 12-070</p>  <p>PTFE-Dichtungsring <i>PTFE-sealing ring</i> 12-069</p> |  <p>Dichtungsring beiderseits feinprofiliert <i>sealing ring both sides moulded</i> 12-075 Kupfer/<i>copper</i> 12-076 Weicheisen/<i>soft iron</i> 12-077 Edelstahl/<i>stainl. steel</i></p> |

Material Stahl, Edelstahl, Messing, PA, PP u.w. sowie andere Ausführungen auf Anfrage.
material steel, stainless steel, brass, PA, PP a.o. as other types on request as well.

Druckluftzubehör accessories for compressed air

| | | |
|--|---|--|
|  <p>Dichtungsring <i>flange gasket</i> 12-080 asbestfreier Faserstoff ähnlich DIN 2690, 2 mm dick <i>asbestos-free material</i> 12-081 Graphit/<i>graphite</i></p> |  <p>Schmierstoffgeber/ <i>lubricator</i> 12-139</p> |  <p>PTFE-Dichtband Gewinde Dichtfaden / <i>PTFE-sealing tape</i> 12-145</p> |
| <p>Kegel-Schmiernippel DIN 71412/conical lubrication nipple</p> | | |
|  <p>Außengewinde/<i>male thread</i> 12-110 Stahl/<i>steel</i> 12-111 Messing/<i>brass</i></p> <p>Schaft/<i>with shaft</i> 12-110.1 Stahl/<i>steel</i> 12-111.1 Messing Messing / <i>brass</i></p> |  <p>Außengewinde/ <i>male thread</i> 12-112 Stahl/<i>steel</i> 12-113 Messing/<i>brass</i></p> |  <p>Außengewinde/<i>male thread</i> 12-114 Stahl/<i>steel</i> 12-115 Messing/<i>brass</i></p> |
| <p>Kugel-Schmiernippel DIN 3402/ball type lubrication nipple</p> | | |
|  <p>Außengewinde/<i>male thread</i> 12-116 Stahl/<i>steel</i> 12-117 Messing/<i>brass</i></p> |  <p>Außengewinde/ <i>male thread</i> 12-120 Stahl/<i>steel</i> 12-121 Messing/<i>brass</i></p> |  <p>Schaft/<i>shaft</i> 12-122 Stahl/<i>steel</i> 12-123 Messing/<i>brass</i></p> |
| <p>Trichter-Schmiernippel DIN 3405/cup head lubrication nipple</p> | | |
|  <p>Außengewinde/<i>male thread</i> 12-124 Stahl/<i>steel</i> 12-125 Messing/<i>brass</i></p> |  <p>Außengewinde/ <i>male thread</i> 12-128 Stahl/<i>steel</i> 12-129 Messing/<i>brass</i></p> |  <p>Schaft/<i>with shaft</i> 12-130 Stahl/<i>steel</i> 12-131 Messing/<i>brass</i></p> |
|  | <p>Flach-Schmiernippel DIN 3404 mit Außengewinde / <i>flat type lubricating nipple male thread</i> 12-132 Stahl/<i>steel</i> 12-133 Messing/<i>brass</i></p> | |

Material Stahl, Edelstahl, Messing, PA, PP u.w. sowie andere Ausführungen auf Anfrage.
material steel, stainless steel, brass, PA, PP a.o. as other types on request as well.

Архангельск (8182)63-90-72
Астана +7(7172)727-132
Белгород (4722)40-23-64
Брянск (4832)59-03-52
Владивосток (423)249-28-31
Волгоград (844)278-03-48
Вологда (8172)26-41-59
Воронеж (473)204-51-73
Екатеринбург (343)384-55-89
Иваново (4932)77-34-06
Ижевск (3412)26-03-58
Казань (843)206-01-48

Калининград (4012)72-03-81
Калуга (4842)92-23-67
Кемерово (3842)65-04-62
Киров (8332)68-02-04
Краснодар (861)203-40-90
Красноярск (391)204-63-61
Курск (4712)77-13-04
Липецк (4742)52-20-81
Магнитогорск (3519)55-03-13
Москва (495)268-04-70
Мурманск (8152)59-64-93
Набережные Челны (8552)20-53-41

Нижний Новгород (831)429-08-12
Новокузнецк (3843)20-46-81
Новосибирск (383)227-86-73
Орел (4862)44-53-42
Оренбург (3532)37-68-04
Пенза (8412)22-31-16
Пермь (342)205-81-47
Ростов-на-Дону (863)308-18-15
Рязань (4912)46-61-64
Самара (846)206-03-16
Санкт-Петербург (812)309-46-40
Саратов (845)249-38-78

Смоленск (4812)29-41-54
Сочи (862)225-72-31
Ставрополь (8652)20-65-13
Тверь (4822)63-31-35
Томск (3822)98-41-53
Тула (4872)74-02-29
Тюмень (3452)66-21-18
Ульяновск (8422)24-23-59
Уфа (347)229-48-12
Челябинск (351)202-03-61
Череповец (8202)49-02-64
Ярославль (4852)69-52-93